



Commercial Microwave Oven

INSTRUCTION MANUAL

MODEL:MW-251000120

Read these instructions carefully before using your microwave oven, and keep them for further use.

If you follow the instructions, your oven will provide you with many years of good service.

PLEASE SAVE THESE INSTRUCTIONS

PRECAUTIONS TO AVOID POSSIBLE EXPOSURE TO EXCESSIVE MICROWAVE ENERGY

- (a) Do not attempt to operate this oven with the door open since open door operation can result in harmful exposure to microwave energy.
It is important not to deactivate or tamper with the safety interlocks.
- (b) Do not place any object between the oven's front side inner surface and the door or allows soil or cleaner residue to accumulate on sealing surfaces.
- (c) Do not operate the oven if it is damaged. Please ensure that the oven door closes properly and that there is no damage to the following components:
 - (1) DOOR (bent)
 - (2) HINGES AND LATCHES (broken or loosened)
 - (3) DOOR SEALS AND SEALING SURFACES
- (d) The oven should not be adjusted or repaired by anyone except properly qualified service personnel.

Specifications

Model:	MW-251000120
Rated Voltage:	120V~ 60Hz
Rated Input Power (Microwave):	1500W
Rated Output Power (Microwave):	1000W

IMPORTANT SAFETY INSTRUCTIONS

Basic safety precautions should be followed when using electrical appliances, including the following:

WARNING - To reduce the risk of burns, electric shock, fire, injury or exposure to excessive microwave energy:

1. Read all instructions before using the appliance.
2. Read and follow the specific: "**PRECAUTIONS TO AVOID POSSIBLE EXPOSURE TO EXCESSIVE MICROWAVE ENERGY**" found on page 2.
3. This appliance must be grounded. Connect only to properly grounded outlet. See "**GROUNDING INSTRUCTIONS**" found on page 4.
4. Install or locate this appliance only in accordance with the provided installation instructions.
5. Some products such as whole eggs and sealed containers - for example, closed glass jars - could explode and should not be heated in this oven.
6. Use this appliance only for its intended use and as described in the manual. Do not use corrosive chemicals or vapors in this appliance. This type of oven is specifically designed to heat, cook or dry food. It is not designed for industrial or laboratory use.
7. As with any appliance, close supervision is necessary when used by children.
8. Do not operate this appliance if it has a damaged cord or plug, if it is not working properly, or if it has been damaged or dropped.
9. This appliance should be serviced only by qualified service personnel. Contact nearest authorized service facility for examination, repair, or adjustment.
10. Do not cover or block any openings on the appliance.
11. Do not store this appliance outdoors. Do not use this product near water - for example, near a kitchen sink, in a wet basement, near a swimming pool, or similar location.
12. Do not immerse cord or plug in water.
13. Keep cord away from heated surface.
14. Do not let the cord hang over the edge of the table or over the counter.
15. Use only mild, nonabrasive soaps, or detergent applied with a sponge or soft cloth when cleaning the door and oven surfaces that come together when closing the door.
16. To reduce the risk of fire in the oven cavity:
 - 1). Do not overcook food. Pay close attention to the appliance when paper, plastic, or other combustible materials are placed inside the oven to facilitate cooking.
 - 2). Remove wire twist-ties from paper or plastic bag before placing bag in oven.
 - 3). If the material inside the oven ignites, keep oven door closed, turn oven off, and disconnect the power cord, or shut off power at the fuse or circuit breaker panel.
 - 4). Do not use the cavity for storage purposes. Do not leave paper products, cooking utensils, or food in the cavity when not in use.
17. Liquids, such as water, coffee, or tea can overheat beyond the boiling point without appearing to be boiling. Visible bubbling or boiling when the container is removed from the microwave oven is not always present.

THIS COULD RESULT IN VERY HOT LIQUID SUDDENLY BOILING OVER WHEN THE CONTAINER IS DISTURBED OR A UTENSIL IS INSERTED INTO THE LIQUID.

To reduce the risk of personal injury:

- 1) Do not overheat the liquid.
- 2) Stir the liquid both before and halfway through heating it.
- 3) Do not use straight-sided containers with narrow necks.
- 4) After heating, allow the container to stand in the microwave oven for a short period before removing the container.
- 5) Use extreme care when inserting a spoon or other utensil into the container.

PLEASE SAVE THESE INSTRUCTIONS

GROUNDING INSTRUCTIONS

This appliance must be grounded. In the event of an electrical short circuit, grounding reduces the risk of electric shock by providing an escape wire for the electric current. This appliance is equipped with a cord having a grounding wire with a grounding plug. The plug must be plugged into an outlet that is properly installed and grounded.

WARNING - Improper use of the grounding wire or plug can result in a risk of electric shock.

Consult a qualified electrician or serviceman if the grounding instructions are not completely understood, or if doubt exists as to whether the appliance is properly grounded. If it is necessary to use an extension cord, use only a 3-wire extension cord that has a 3-blade grounded plug, and 3-slot receptacle that will accept the plug on the appliance. The marked rating of the extension cord should be equal to or greater than the electrical rating of the appliance.

DANGER - Electric Shock Hazard

Touching some of the internal components can cause serious injury or death. Do not disassemble this appliance.

WARNING - Electric Shock Hazard

Improper use of the grounding wire or plug can result in electric shock. Do not plug into an outlet until appliance is properly installed and grounded.

1. A short power-supply cord is provided to reduce the risks resulting from becoming entangled in or tripping over a longer cord.
2. Longer cord sets or extension cords are available and may be used if care is exercised.
3. If a long cord or extension cord is used:
 - 1) The marked electrical rating of the cord set or extension cord should be greater than the electrical rating of the appliance.
 - 2) The extension cord must be a grounding-type 3-wire cord.
 - 3) The longer cord should be arranged so that it will not drape over the counter top or tabletop where it can be pulled on by children or tripped over unintentionally.

RADIO INTERFERENCE

1. Operation of the microwave oven may cause interference to your radio, TV or similar equipment.
2. If such is the case interference may be reduced or eliminated by taking the following measures:
 - 1) Clean door and sealing surface of the oven
 - 2) Reorient the receiving antenna of the radio or television.
 - 3) Relocate the microwave oven with respect to the receiver.
 - 4) Move the microwave oven away from the receiver.
 - 5) Plug the microwave oven into a different outlet so that the microwave oven and receiver are on different branch circuits.

This device complies with part 18 of the FCC Rules.

UTENSILS

CAUTION - Personal Injury Hazard

Tightly-closed utensils could explode. Closed containers should be opened and plastic pouches should be pierced before cooking.

See the instructions on "Materials you can use in microwave oven or to be avoided in microwave oven."

There may be certain non-metallic utensils that are not safe to use for microwaving. If in doubt, you can test the utensil by following the procedure below.

Utensil Test:

1. Fill a microwave-safe container with 1 cup of cold water (250ml), then add the utensil in question.
2. Cook on maximum power for 1 minute.
3. Carefully touch the utensil. If the empty utensil is warm, do not use it for microwave cooking.
4. Cooking time should not exceed 1 minute.

Materials you can use in microwave oven

Utensils	Remarks
Browning dish	Follow the manufacturer's instructions*. The bottom of browning dish must be at least 3/16 inch (5mm) above the turntable. Incorrect usage may cause the turntable to break.
Dinnerware	Use only microwave-safe items. Follow the manufacturer's instructions*. Do not use cracked or chipped dishes.
Glass jars	Always remove lid. Use only to heat food until just warm. Most glass jars are not heat resistant and may break.
Glassware	Use heat-resistant oven glassware only. Make sure there is no metallic trim. Do not use cracked or chipped dishes.
Oven cooking bags	Follow the manufacturer's instructions*. Do not close with metal tie. Make slits to allow steam to escape.
Paper plates and cups	Use for short-term cooking/warming only. Do not leave oven unattended while cooking.
Paper towels	Use to cover food for reheating and absorbing fat. Use with supervision for a short-term cooking only.
Parchment paper	Use as a cover to prevent splattering or a wrap for steaming.
Plastic	Use only microwave-safe items. Follow the manufacturer's instructions*. Items should be labeled "Microwave Safe". Some plastic containers soften, as the food inside gets hot. "Boiling bags" and tightly closed plastic bags should be slit, pierced or vented as directed on packaging. Use only microwave-safe items. Use to cover food during cooking
Plastic wrap	to retain moisture. Do not allow plastic wrap to touch food.
Thermometers	Use only microwave-safe items (meat and candy thermometers).
Wax paper	Use as a cover to prevent splattering and retain moisture.

Materials to be avoided in microwave oven

Utensils	Remarks
Aluminum tray	May cause arcing. Transfer food into microwave-safe dish.
Food carton with metal handle	May cause arcing. Transfer food into microwave-safe dish.
Metal or metal-trimmed utensils	Metal shields the food from microwave energy. Metal trim may cause arcing.
Metal twist ties	May cause arcing and could cause a fire in the oven.
Paper bags	May cause a fire in the oven.
Plastic foam	Plastic foam may melt or contaminate the liquid inside when exposed to high temperatures.
Wood	Wood will dry out when used in the microwave oven and may split or crack.

SETTING UP YOUR OVEN

Names of Oven Parts and Accessories

Remove the oven and all materials from the carton and oven cavity.

Your oven comes with the following accessories:

Instruction Manual

1

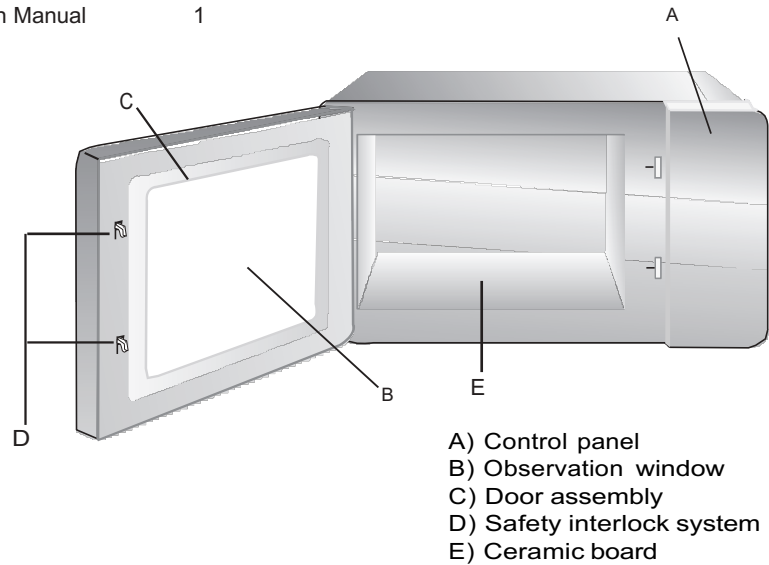

Note: 1) Don't press down on the ceramic board with force.

2) Gently manipulate the utensils during the operation to avoid damaging the ceramic board.

3) After using the microwave, do not touch the ceramic board with your bare hands to avoid scalding due to high temperatures.

Countertop Installation

Remove all packing material and accessories. Examine the oven for any damage such as dents or door. Do not install if oven is damaged.

Cabinet: Remove any protective film found on the outer surface of the microwave oven.

Installation

1. Select a level surface that provides enough open space for the intake and/or outlet vents(Figure1).

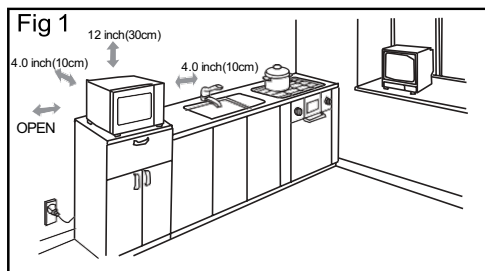

A 10-cm spacing should be kept between the appliance and right and back walls, and a 30-cm spacing should be kept over the top of the appliance. Do not remove the legs from the oven, or block the air intake and exhaust openings. The left side must be open.

- 1) Blocking the intake and/or outlet openings can damage the oven.
- 2) Place the oven as far away from radios and TV as possible. Operation of microwave oven may cause interference to your radio or TV reception.
- 3) Plug your oven into a standard household outlet. Be sure the voltage and the frequency are the same as the voltage and the frequency written on the rating label.
- 4) Warning: The plug, or socket and all electric appliances that are sensitive to heat or moisture should be kept away from the ovens' vents.

Cleaning Instructions

Always keep the oven clean

1. Always keep the glass viewing window, the inner door panel and oven front face of the oven clean.

For best performance and to maintain a high degree of safety, the inner door panel and the face of the oven should be free of food or grease build-up. Wipe these parts with a mild detergent, rinse and wipe dry. Never use abrasive powders or pads.

2. Cleaning the control panel and plastic parts.

Do not apply a detergent or an alkaline liquid spray to the control panel and plastic parts, as this may cause damage these parts.

Use a dry cloth (not a soaked cloth) to clean these parts.

3. Cleaning the oven interior.

After using the oven, clean up spilled liquids, spattered oil and food debris as quickly as possible. If the oven is used when dirty, efficiency drops and the dirt gets stuck on the oven surface and may cause bad odors. Clean the interior with a cloth soaked in luke-warm water with a mild detergent dissolved in it, then rinse the soap off with a damp cloth.

CAUTION: Do not wipe plastic and painted sections of the oven with bleach, thinners or other cleaning agents, as this may cause these parts to dissolve or change shape.

OPERATION

Control Panel and Features

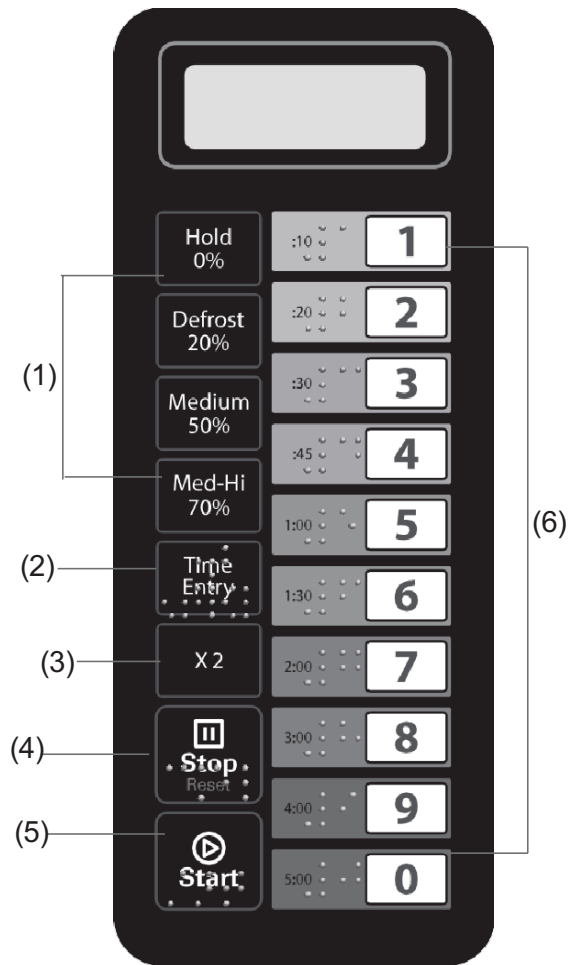

- (1) Power Buttons
- (2) Time Cook Button
- (3) X2 Button
- (4) Stop/Reset Button
- (5) Start Button
- (6) Number Buttons

OPERATION INSTRUCTION

Five power levels are available.

Level	High	M. High	Med.	Defrost	Hold
Power	100%	70%	50%	20%	0%
Display	PL10	PL7	PL5	PL2	PL0

Appendix. A User Options

Items in bold are the default values.

Option	Setting	Description
1 EOC Tone	OP:10	3 beeps
	OP:11	Continuous beep
	OP:12	5 quick beeps, continuous
2 Beeper Volume	OP:20	Beeper Off
	OP:21	Low
	OP:22	Medium
3 Beeper On/Off	OP:23	High
	OP:30	Keybeep Off
4 Keyboard Window	OP:31	Keybeep On
	OP:40	15 seconds
	OP:41	30 seconds
	OP:42	60 seconds
5 On the Fly	OP:43	120 seconds
	OP:50	On-the-Fly Disable
6 Door Reset	OP:51	On-the-Fly Enable
	OP:60	Door reset Disable
7 Max time	OP:61	Door Reset Enable
	OP:70	60 Minute Maximum Cook Time
8 Manual Programming	OP:71	10 Minute Maximum Cook Time
	OP:80	Manual Programming Disable
9 Double Digit	OP:81	Manual Programming Enable
	OP:90	Single Digit Mode - 10 programs
	OP:91	Double Digit Mode - 100 programs

Appendix. B Default Cook Times

The oven is shipped with the following Preset Cook Times unless otherwise noted in the product's specification.

Button	Display (Time)	Power	Cook Factors
1	0:10	100%	80%
2	0:20	100%	80%
3	0:30	100%	80%
4	0:45	100%	80%
5	1:00	100%	80%
6	1:30	100%	80%
7	2:00	100%	80%
8	3:00	100%	80%
9	4:00	100%	80%
0	5:00	100%	80%

1. Power Up

" _ _ _ _ " displays when the oven is electrified for the first time. If the "  " button pressed, the oven will change to the Idle Mode.

Stop
Reset

Note: Under the Idle Mode, no button can be pressed.

2. Idle Mode

- 1) Entry: The oven will enter Idle Mode after a preset number of seconds has expired. The number of seconds is determined by the keyboard Timeout Window, set by user under Option 4.
- 2) During the Idle Mode, the LED screen is blank and there is no activity in the oven.
- 3) Opening and then closing the oven door will make the oven go from Idle mode to Ready Mode.

3. Ready Mode

- 1) Opening and closing the door while the oven is in Idle Mode make the oven enter the Ready Mode.
- 2) During the Ready Mode, the LED screen displays "0:00".
- 3) From the Ready Mode, the oven can enter into almost all other modes.
- 4) Only the fan and lamp work.

4. Door Open Mode

- 1) While the door of the oven is opened, the oven will enter into the Door Open Mode.
- 2) During this mode, LED screen is blank. Only the fan and the oven lamp work.
- 3) When the door is closed, if User Option OP:60 is selected and the oven was running a Manual Cook Mode or a Present Program Cook Mode, the oven will enter the Pause Mode.
In all other cases, the oven will return to the Ready Mode when the User Option OP:61 is selected.



5. Pause Mode

1) While in Manual Cook Mode, or Preset Program Cook Mode, if the door is opened or closed, or if the " " pad is pressed, the oven will enter the Pause Mode.

Stop
Reset

2) While paused, the LED screen will display the remaining cooking time.

3) Only the fan and lamp work.

4) Once the Pause Mode has expired, the oven will enter the Idle Mode in the same way as it entered the Ready Mode, depending on the User Option 4. Additionally, if the " " button is pressed, the oven will immediately enter the Ready Mode. If the " " button, the oven will enter Ready Mode.

Start

Stop
Reset



6. Manual Cook Entry Mode

1) While the oven is in the Ready Mode, press the " " pad on the keyboard to put the oven into Manual Cook Entry Mode.

2) During this mode, the LED screen displays "00:00".

3) If you press " Hold " " Defrost " " Medium " or " Med-Hi " button to select the power level, the LED screen will display the related power. If the same button is pressed twice, the power will change to PL10. If no power is chosen, "PL10" is the default setting.

4) Only the fan and lamp work.

5) During the setting process, press " " to enter the Manual Cook Mode. Press " " to enter the Ready Mode.



Start

Stop
Reset

7. Manual Cook Mode

1) Pressing the " " pad will cause the oven to begin the Manual Cook Mode.

2) During this mode, the remaining cooking time will display. The fan and oven lamp will work.

3) Once the cooking program is finished, the oven will enter End of Cook Cycle Mode. If you press the " " button under this mode, the oven will enter the Pause Mode.



Stop
Reset

8. End of Cook Cycle Mode

- 1) After the time has expired in a Manual Cook Mode or in a Preset Program Cook Mode, the oven will enter into The End of Cook Cycle Mode.
- 2) During this mode, the LED screen displays "End".
- 3) If either User Option OP:11 or "OP:12" is selected, the oven's buzzer will continue to sound until the user acknowledges this by either opening then closing the door or by pressing the " Stop Reset" pad. If User Option OP:10 is selected, after the 3-second beep, the oven will go into the Ready Mode.

9. Preset Program Cook Mode

- 1) This mode allows cooking of food items through a one pad touch operation. While in Ready Mode, pressing one of ten digit keys on the keyboard will cause the oven to run the Preset Program associated with that key.
- 2) The LED screen displays the remaining cooking time. If you are using the multi-stage cooking feature, the time displayed on the screen is the total cooking time and not the cooking time of a particular cooking stage.
- 3) Once the cooking program is finished, the oven will enter the End of Cook Cycle Mode.

If you press the " Stop Reset" button under this mode, the oven will enter the Pause Mode.



10. On the Fly Cooking

- 1) While the oven is in the Cook Mode or the Pause Mode, if User Option OP:51 is selected the preset cooking program will start automatically after the corresponding button is pressed.
- 2) The LED screen displays the remaining cooking time.
- 3) When the cooking program finished, the oven will enter the End of Cook Cycle Mode.

If you press the " Stop Reset" button under this mode, the oven will enter the Pause Mode.

11. Programming Mode

This mode allows the user to assign cook times and power levels a one touch button.

- 1) Open the door and press "1" for 5 seconds. The buzzer will sound once and enter to Programming Mode.
- 2) The LED screen displays "PROGRAM".
- 3) Press any number (0 to 9) and the LED screen will display the saved time. You can then input the time you need.
- 4) Press " Hold " " Defrost " Medium " or " Med-Hi " to input the power level.
0% , 20% , 50% , 70%
The LED screen will display the related power. If the same button pressed twice, the power will change to PL10. If no power is chosen, the default power is "PL10".
- 5) To change the cooking factors: If press "X2" button, the LED screen will display "CF:XX". The default factor is 80% and the LED screen displays "CF:80". If you need to change the cooking power, just press the corresponding number on the touch pad to set.
- 6) After setting the time and power, press the "  ". After 30s, the cooking program will be saved. Once the program is saved, the LED screen displays "PROGRAM".
- 7) If the cooking time entered exceeds the MAX. time (User Option &), the buzzer will sound 3 times after pressing the "  " to signal that the time entered cannot be saved. The LED screen will once again display "PROGRAM" meaning that the preset time cannot be changed.
- 8) Close the door, the oven will turn back to the Ready Mode.

By pressing the "  " button during setting process, the oven will enter the Door Open Mode.

The program that is not saved will be lost. If there is a program, press the corresponding number button, the saved program will start. If there is no saved program, the buzzer will sound when pressing the number button to indicate that there is no saved program for that button. For example: set the program as memory cooking.

Program; Power level PL7 and cooking time is 1 minute and 25 seconds.

Step 1: In Ready Mode, press "1" for 5 seconds. The LED screen displays "PROGRAMS".

Step 2: Press "3". The program will be saved under button"3".

Step 3: Press "1", "2" and "5" to input the cooking time. Step 4: Press "

Med-Hi " button," PL7" displays. Setting finished.
70%

Step 5: Press the "  " to save. Next time you wish to use this program, simply press "3", and the related program will start.

Note:

1. If the electricity is cut off, the saved program will not be lost.
2. If you need to reset the program, simply repeat the steps above.
3. If you press the "  " at the last step, it will turn back to the Door Open Mode and the setting will be lost.

12. Double Quantity cooking

- 1) In the Ready Mode, the "X2" button and then press the number buttons 0-9. After 5 seconds, the oven will start cooking with the quantity preset cooking time.
- 2) Press "X2". The LED screen displays "DOUBLE".. When press number buttons, the LED screen will display the quantity preset time.
For example, the preset time for "5" is 1 minute. Then press "X2", the time will change to $1:00 \times (1+0.8) = 1:48$
- 3) Once the cooking program is finished, the oven will enter the End of Cook Cycle Mode.

13. Stage Cooking Programming

This allows the user to cook food items using various combination of Power Levels.

- 1) Under the Cooking Mode or the Memory Mode, the most cooking stages that can be set is three.
After setting the power and time for the first stage, press "Time Entry" to set the second stage. Use the same steps to set the third stage.
- 2) When setting the second or the third stage, press the "Time Entry" button. The LED screen displays "S-2" or "S-3" displays.
- 3) Press the "Start" button to start cooking.

Example: Setting three stages using Memory Mode. The first stage is PL7 and the time is 1 minute 25 seconds. The second stage is PL5 and the time is 5 minutes and 40 seconds.

The steps are follow.

- a. Ready state, press "1" for 5 seconds. The LED screen displays "PROGRAM".
- b. Press number buttons "3" to save the program in "3".
- c. Press "1", "2", "5" to input the cooking time. The LED screen displays "1:25".
- d. Press "Med-Hi 70%". The LED screen displays "PL7".



The first stage is saved.

- e. Press "Time Entry". The LED screen displays "S-2".
- f. Press the "5", "4", "0" button. The LED screen displays "5:40".
- g. Press "Medium 50%". The LED screen displays "PL5".



The second stage is saved.

- h. Press "Start" to save the program.

14. User Option Mode

- 1) Open the oven door and press "2" for 5 seconds. The buzzer sounds once and enter this mode.
- 2) The LED screen displays "OP: - -".
- 3) Press any number button to enter the corresponding mode setting.
For example: to set the sound level of the buzzer to medium. Press " 2 ", the LED screen will display "OP:22" displays.
If you want to change the sound level, keep pressing "2". The LED screen displays "OP:20", "OP:21", "OP:22", "OP:23", "OP:20" in cycle.
- 4) Press "  " to save the current setting. Once saved, the LED screen displays "OP: - -" again.
Start
- 5) During the setting process, press "  " to enter Door Open Mode. Close the door will enter Ready Mode.
Stop
Reset
- 6) If "  " button not pressed at the last step, the program cannot be saved but stay at previous way.
Start

15. Service Mode

- 1) Open the oven door and press "3" for 5 seconds to enter the Service Mode.
- 2) The LED screen displays "SERVICE".
- 3) To check how long the door was closed and opened, just press "3", The LED screen will display the times.
- 4) Press "  " and then press "4". After 3 seconds, the message will be cancelled. The LED screen displays "4-CL".
Start
- 5) Press "  " to enter the Door Open Mode. Closing the door will make the oven enter the Ready Mode.
Stop
Reset

16. Inquiry Function

During the microwave cooking process, press "  " to check the power level. The LED screen displays the power level for 2 seconds, then the oven will enter its previous state.

This function is available for multi-stage cooking.

17. Factory-default setting

In the Power Up and Ready Mode, press "  " and " 0 " go to the factory—default settings.
Start

MAINTENANCE

Troubleshooting

Identify the problem by using the chart below and try the solutions mentioned. If the microwave oven still does not work properly, contact the nearest authorized service center.

TROUBLE	POSSIBLE CAUSE	POSSIBLE REMEDY
Oven will not start	<ul style="list-style-type: none"> a. Electrical cord for oven is not plugged in. b. Door is open. c. Wrong operation is set. 	<ul style="list-style-type: none"> a. Plug into the outlet. b. Close the door and try again. c. Check instructions.
Arcing or sparking	<ul style="list-style-type: none"> a. Materials to be avoided in microwave oven were used. b. The oven is operated when empty. c. Spilled food remains in the cavity. 	<ul style="list-style-type: none"> a. Use microwave-safe cookware only. b. Do not operate with oven empty. c. Clean cavity with wet towel.
Unevenly cooked foods	<ul style="list-style-type: none"> a. Materials to be avoided in microwave oven were used. b. Food is not defrosted completely. c. Cooking time, power level is not suitable. d. Food is not turned or stirred. 	<ul style="list-style-type: none"> a. Use microwave-safe cookware only. b. Completely defrost food. c. Use correct cooking time, power level. d. Turn or stir food.
Overcooked foods	Cooking time, power level is not suitable.	Use correct cooking time, power level.
Undercooked foods	<ul style="list-style-type: none"> a. Materials to be avoided in microwave oven were used. b. Food is not defrosted completely. c. Oven ventilation ports are restricted. d. Cooking time, power level is not suitable. 	<ul style="list-style-type: none"> a. Use microwave-safe cookware only. b. Completely defrost food. c. Check to see that oven ventilation ports are not restricted. d. Use correct cooking time, power level.
Improper defrosting	<ul style="list-style-type: none"> a. Materials to be avoided in microwave oven were used. b. Cooking time, power level is not suitable. c. Food is not turned or stirred. 	<ul style="list-style-type: none"> a. Use microwave-safe cookware only. b. Use correct cooking time, power level. c. Turn or stir food.



VANCOUVER
26895 Gloucester Way,
Langley, BC
V4W 3Y3
T: (604) 607-8850
F: (604) 607-8820

GUELPH
515 Hanlon Creek Blvd.,
Guelph, ON
N1C 0A1
T: (519) 822-1895